

Technical data sheet



Product features

Combi convection steam oven electric 7x GN 1/1, 12,6 kW, direct steam, touch screen, automatic cleaning, right door

Model	SAP Code	00014258
--------------	-----------------	----------



- Steam type: Injection
- Number of GN / EN: 7
- GN / EN size in device: GN 1/1
- GN device depth: 65
- Control type: Touchscreen + buttons
- Display size: 7"
- Humidity control: Yes, indirect measuring
- Advanced moisture adjustment: No
- Delta T heat preparation: Yes
- Multi level cooking: Drawer program - control of heat treatment for each dish separately
- Door constitution: Vented safety double glass, removable for easy cleaning

SAP Code	00014258	Steam type	Injection
Net Width [mm]	907	Number of GN / EN	7
Net Depth [mm]	752	GN / EN size in device	GN 1/1
Net Height [mm]	837	GN device depth	65
Net Weight [kg]	105.00	Control type	Touchscreen + buttons
Power electric [kW]	12.600	Display size	7"
Loading	400 V / 3N - 50 Hz		

Technical data sheet



Technical drawing

Combi convection steam oven electric 7x GN 1/1, 12,6 kW, direct steam, touch screen, automatic cleaning, right door

Model

SAP Code

00014258

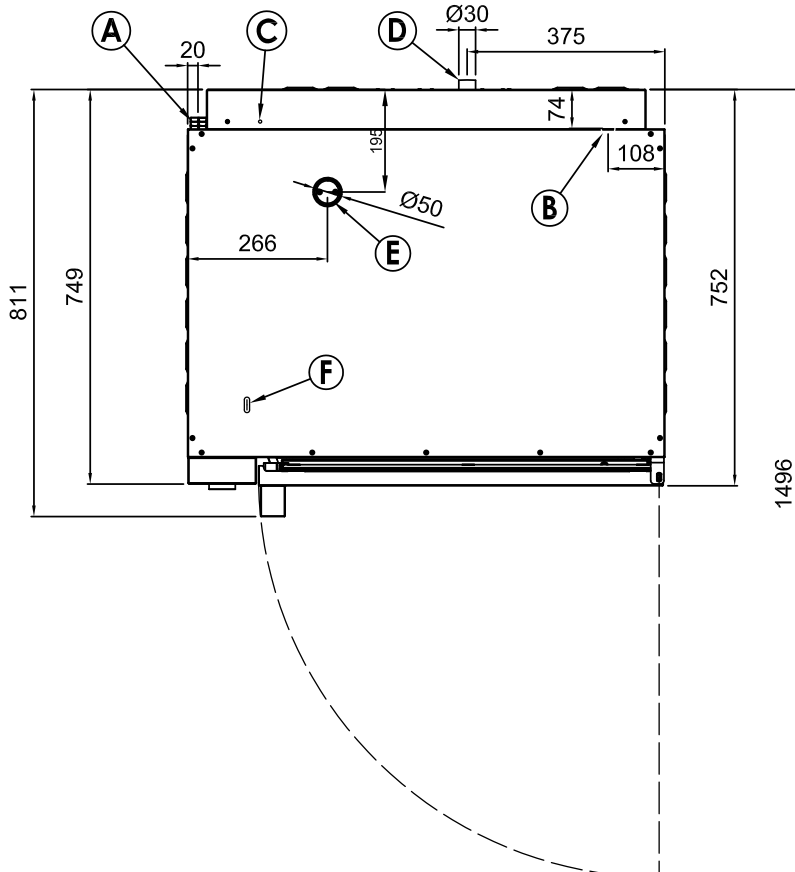
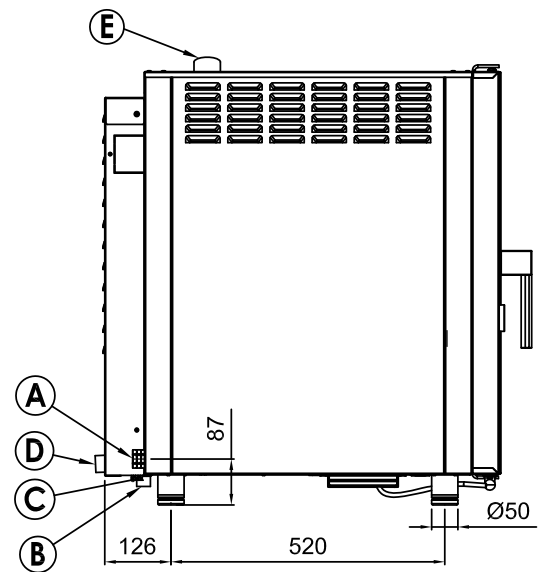
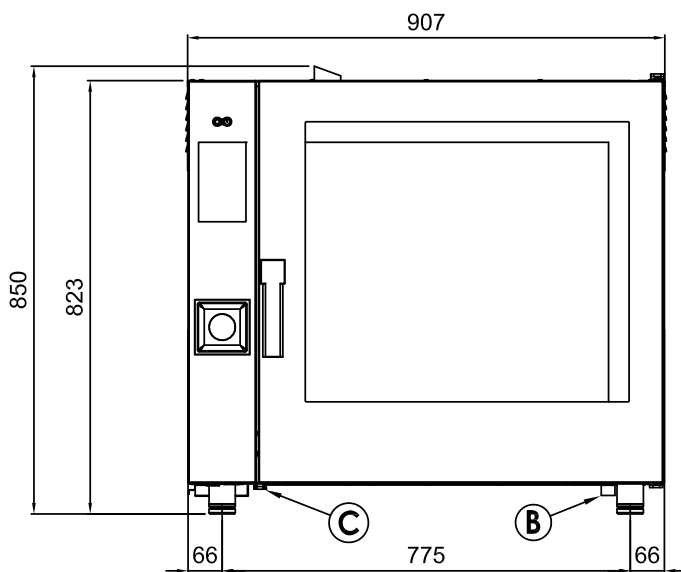

- A Electrical connection
- B Softened water inlet (G3/4)
- C Equipotential bonding
- D Drain (Ø30)
- E Humidity discharge (Ø50)
- F Detergent hose inlet

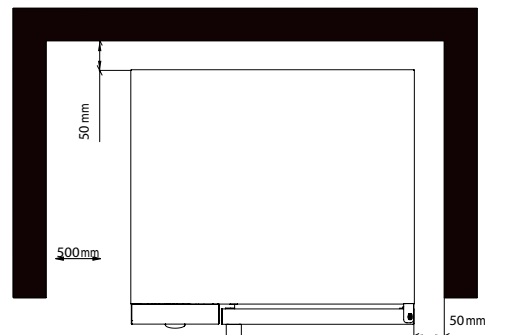

* Clearance requirements

NOTE

* Drain line must be vented

Technical data sheet



Technical parameters

Combi convection steam oven electric 7x GN 1/1, 12,6 kW, direct steam, touch screen, automatic cleaning, right door

Model

SAP Code

00014258

1. SAP Code:

00014258

2. Net Width [mm]:

907

3. Net Depth [mm]:

752

4. Net Height [mm]:

837

5. Net Weight [kg]:

105.00

6. Gross Width [mm]:

940

7. Gross depth [mm]:

900

8. Gross Height [mm]:

970

9. Gross Weight [kg]:

125.00

10. Device type:

Electric unit

11. Power electric [kW]:

12.600

12. Loading:

400 V / 3N - 50 Hz

13. Material:

AISI 304

14. Device color:

Stainless steel

15. Humidity control:

Yes, indirect measuring

16. Stacking availability:

Yes

17. Control type:

Touchscreen + buttons

18. Additional information:

possibility of reverse door opening - handle on the right side (must be specified when ordering)

19. Steam type:

Injection

20. Sturdier version:

Yes

21. Chimney for moisture extraction:

Yes

22. Delayed start:

Yes

23. Display size:

7"

24. Delta T heat preparation:

Yes

25. Unified finishing of meals EasyService:

Yes

26. Night cooking:

Yes

27. Washing system:

Open

28. Detergent type:

Liquid washing detergent + water rinse

Technical data sheet



Technical parameters

Combi convection steam oven electric 7x GN 1/1, 12,6 kW, direct steam, touch screen, automatic cleaning, right door

Model

SAP Code

00014258

29. Multi level cooking:

Drawer program - control of heat treatment for each dish separately

30. Advanced moisture adjustment:

No

31. Slow cooking:

from 50 °C

32. Fan stop:

Interruption when door is opened, not braked

33. Lighting type:

LED lighting in the door, on one side

34. Cavity material and shape:

AISI 304, with rounded corners for easy cleaning

35. Reversible fan:

Yes

36. Sustance box:

Yes

37. Heating element material:

Incoloy

38. Probe:

Yes

39. Shower:

Manual (optional)

40. Distance between the layers [mm]:

74

41. Smoke-dry function:

Yes

42. Interior lighting:

Yes

43. Low temperature heat treatment:

Yes

44. Number of fans:

1

45. Number of fan speeds:

3

46. Number of programs:

1000

47. USB port:

Yes, for uploading recipes and updating firmware

48. Door constitution:

Vented safety double glass, removable for easy cleaning

49. Number of preset programs:

100

50. Number of recipe steps:

9

51. Minimum device temperature [°C]:

50

52. Maximum device temperature [°C]:

300

53. Device heating type:

Combination of steam and hot air

54. HACCP:

Yes

55. Number of GN / EN:

7

56. GN / EN size in device:

GN 1/1

Technical data sheet



Technical parameters

Combi convection steam oven electric 7x GN 1/1, 12,6 kW, direct steam, touch screen, automatic cleaning, right door

Model	SAP Code	00014258
--------------	-----------------	----------

57. GN device depth:

65

58. Food regeneration:

Yes